

METER OF NETWORK PARAMETERS
ND20



USER MANUAL



Contents

1. APPLICATION	5
2. METER SET	6
3. BASIC REQUIREMENTS AND OPERATIONAL SAFETY	6
4. INSTALLATION	7
5. METER DESCRIPTION	8
6. ND20 METER PROGRAMMING.....	12
7. SOFTWARE UPGRADES.....	35
8. RS485 INTERFACE.....	37
9. ERROR CODES	60
10. TECHNICAL DATA	62
11. ORDERING CODES.....	66
12. MAINTENANCE AND GUARANTEE	68

1. APPLICATION

The N20D meter is a digital programmable panel meter destined for the measurement of single-phase power network parameters (2-wire network) and 3-phase, 3,4-wire network in balanced and unbalanced systems with the simultaneous display of measured quantities on a LCD display. The meter enables the control and optimization of power electronics devices, systems and industrial installation operations.

The meter ensures the measurement of: rms values of voltage and current, active, reactive and apparent power, active, reactive energy, power factors, frequency, 15, 30, 60 minutes' mean active power, archive of power profile, THD and harmonic measurements. Additionally, the current value in the neutral wire is calculated. Voltages and currents are multiplied by given voltage and current ratios of measuring transformers. Indications of power and energy take into consideration values of programmed ratios. The value of each measured quantity can be transmitted to the master system through the RS-485 interface. The relay output signals the overflow of the chosen quantity, and the pulse output can be used for the consumption check of 3-phase active and reactive energy.

The meter has additionally a continuous current output.

The meter has a galvanic separation between respective blocks:

- supply,
- measuring inputs,
- voltage and current inputs,
- analog output,
- RS-485 output,
- impulse output.

2. METER SET

The set of the ND20 meter is composed of:

1. ND20 meter 1 pc.
2. user's manual 1 pc.
3. guarantee card 1pc
4. seal..... 1 pc.
5. holders to fix the meter in the panel... 4 pcs

3. BASIC REQUIREMENTS AND OPERATIONAL SAFETY



In the safety service scope, the ND20 meter meets to requirements of the EN 61010 -1 standard.

Observations Concerning the Operational Safety:

- All operations concerning transport, installation, and commissioning as well as maintenance, must be carried out by qualified, skilled personnel, and national regulations for the prevention of accidents must be observed.
- Before switching the meter on, one must check the correctness of connection to the network.
- Before removing the meter housing, one must switch the supply off and disconnect measuring circuits
- The removal of the meter housing during the guarantee contract period may cause its cancellation.
- The ND20 meter is destined to be installed and used in industrial electromagnetic environment conditions.
- One must remember that in the building installation, a switch or a circuit-breaker should be installed. This switch should be located near the device, easy accessible by the operator, and suitably marked.

4. INSTALLATION

The ND20 meter is adapted to be fixed on a panel by means of holders. The fitting way is presented on the fig.1.

Housing overall dimensions: 96 x 96 x 77 mm. At the rear side of the meter, there are screw terminal strips which enable the connection of external wires with a cross-section up to 2.5 mm².

One must prepare a 92.5^{+0.6} x 92.5^{+0.6} mm cut-out in the panel. The material thickness which the panel is made from should not exceed 15 mm. Insert the meter from the frontal panel side with the disconnected supply voltage. After the insertion into the hole, fix the meter by means of holders.

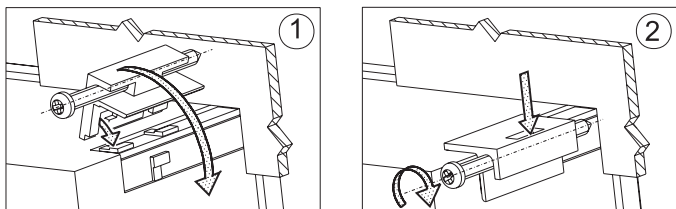

Fig. 1. Meter fitting

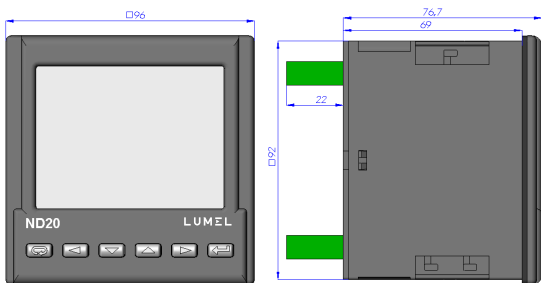

Fig. 2 Meter overall dimensions

5. METER DESCRIPTION

5.1 Current Inputs

All current inputs are galvanically isolated (internal current transformers). The meter is adapted to co-operate with external measuring current transformers. Displayed current values and derivative quantities are automatically recoun in relation to the introduced external current transformer ratio. Current inputs are defined in the order as 1 A or 5 A.

5.2 Voltage Inputs

Quantities on voltage inputs are automatically converted acc. to the introduced ratio of the external voltage transformer. Voltage inputs are defined in the order as $3 \times 57.7/100 \text{ V}$, $3 \times 230/400 \text{ V}$.

5.3 Connection Diagrams

a)

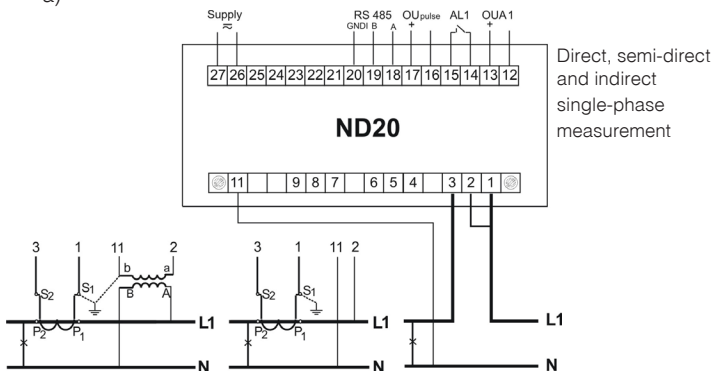

b)

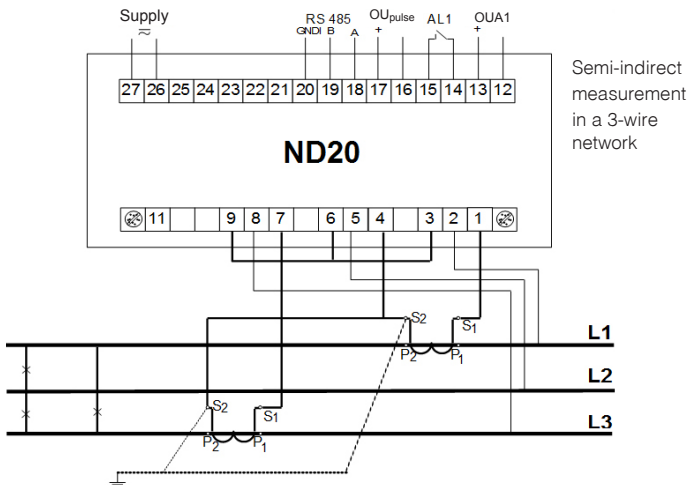
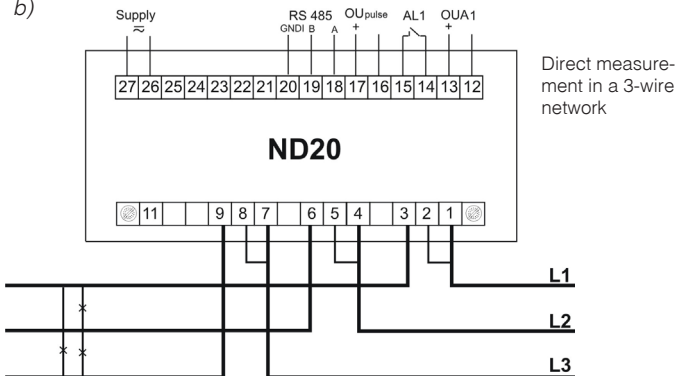

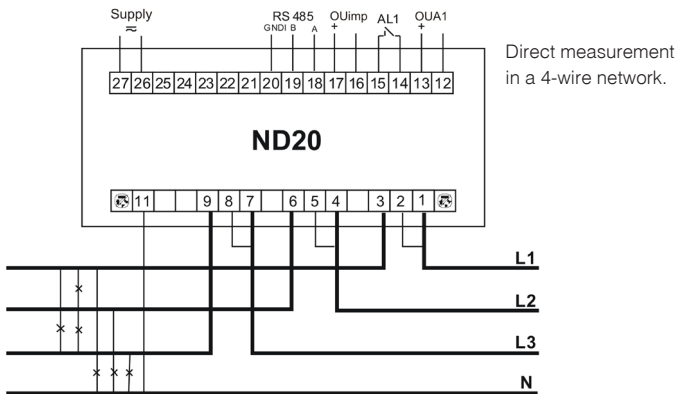
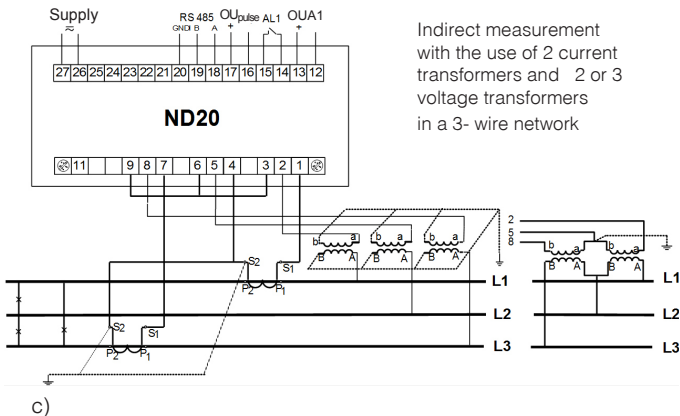

Semi-indirect measurement
in a 4-wire network.

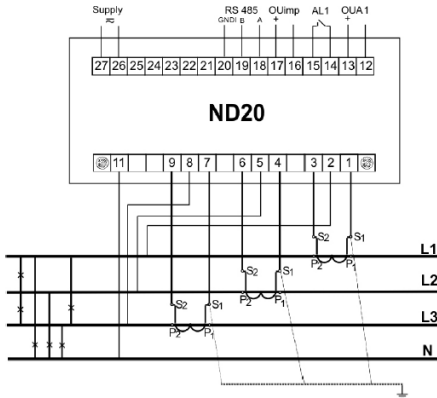

Indirect measurement with
the use of 3 current trans-
formers and 2 or 3 voltage
transformers in a
4-wire network.

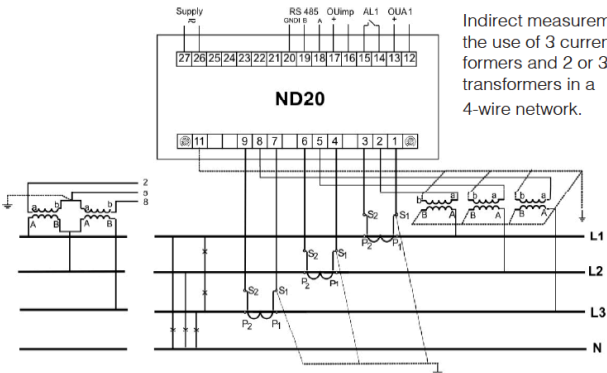

Fig 3. Meter connection diagrams in a:
a) single-phase network, b) 3-phase - 3 wire network,
c) 3-phase - 4-wire network

6. ND20 PROGRAMMING

6.1 Frontal Panel

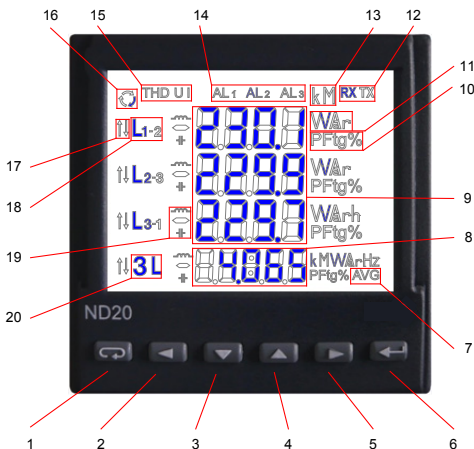

Fig 4. Frontal panel

Description of the frontal panel:

- | | |
|--|--|
| 1 – abandon push-button – ESC | 11 – units of displayed values |
| 2 – push-button to displace to the left | 12 – symbols of digital data transmission |
| 3 – push-button to decrease the value | 13 – multipliers of basic values |
| 4 – push-button to increase the value | 14 – symbols of alarm switching on/occurrence |
| 5 – push-button to displace to the right | 15 – symbols of harmonic value, THD display |
| 6 – acceptance push-button - ENTER | 16 – symbols of energy flow |
| 7 – symbol of displayed value of averaged active power | 17 – symbols of min / max quantities |
| 8 – display field of mean values, frequency, time, power guard | 18 – symbols of quantity affiliation to respective phase |
| 9 – display field of basic quantities, energy, THD, harmonics, date (rows 1, 2, 3) | 19 – symbols of power, energy character |
| 10 – symbols indicating the display of power factor, power tangent and THD (row 4) | 20 – symbol of 3-phase quantity display |

6.2 Messages after Switching the Supply on

After switching the supply on, the meter performs the display test and display the **nd20** meter name, rated current and voltage, the current program version, and next displays the measured values.

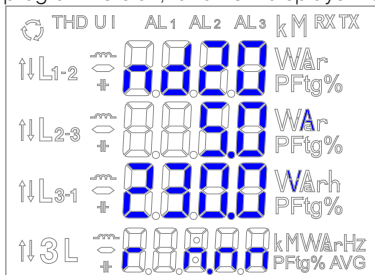





where: n.nn is the number of the current program version or the number of the custom-made version.

Fig. 5. Message after starting the meter

Caution! If on displays the message **Err Cal** or **Err EE** appears, one must contact the service shop.



6.3 Monitoring of Parameters

In the measuring mode, quantities are displayed acc. to settled tables.



The pressure of the  push-button (left) or  push-button (right) causes the transition between displayed quantities. The pressure of the  push-button (Enter) causes the transition between mean and additional displayed values. The pressure of the  push-button (down) causes the monitoring of the minimum value, however the pressure of the  push-button (up) causes the monitoring of the maximum value.

The pressure of the  (ESC) push-button during the monitoring of these values, erases suitably minimum or maximum values. During the operation in the measuring mode of all harmonics (ALL-table 3), instead

of harmonic energy, harmonic percentage values are displayed.

Through  and  push-buttons, one can switch between successive harmonics. The harmonic no is alternately displayed with the value. Through the RS-485 interface one can set up the values, that would be visualized (starting from version 1.02).



The error display is described in the chapter 8.

When displaying the reactive power, a marker indicating the load character is displayed, capacitive () or inductive ()

Displayed quantities in the field 9 (fig. 4.) for 3-phase 4-wire measurement mode 3Ph/4W and single-phase 1Ph/2W are presented in the table 1a and 1b.

Table 1a

Backlit symbols		L ₁ , V L ₂ , V L ₃ , V	L ₁₋₂ , V L ₂₋₃ , V L ₃₋₁ , V	L ₁ , A L ₂ , A L ₃ , A	L ₁ , W L ₂ , W L ₃ , W	L ₁ , Var L ₂ , Var L ₃ , Var	L ₁ , VA L ₂ , VA L ₃ , VA	L ₁ , PF L ₂ , PF L ₃ , PF	L ₁ , tg L ₂ , tg L ₃ , tg	kWh
Displayed values	row 1	U1	U12 ¹	I1	P1	Q1	S1	PF1	tg1	Imported active energy ² EnP
	row 2	U2 ¹	U23 ¹	I2 ¹	P2 ¹	Q2 ¹	S2 ¹	PF2 ¹	tg2 ¹	
	row 3	U3 ¹	U31 ¹	I3 ¹	P3 ¹	Q3 ¹	S3 ¹	PF3 ¹	tg3 ¹	
Displaying		optional								

Backlit symbols		-, kWh	 kVarh	 kVarh	L ₁ , U/ THD U L ₂ , U/ THD U L ₃ , U/ THD U	L ₁ , I/ THD I L ₂ , I/ THD I L ₃ , I/ THD I
Displayed values	row 1	Exported active energy ²	reactive inductive energy / reactive positive energy ²	reactive capacitive energy / reactive negative energy ²	Uh1 V / THD1 %	Ih1 A / THD1 %
	row 2				Uh2 V / THD2 % ¹	Ih2 A / THD2 % ¹
	row 3				Uh3 V / THD3 % ¹	Ih3 A / THD3 % ¹
Displaying		optional				

Backlit symbols		kWh U I	L ₁ , U L ₂ , U L ₃ , U	-, kWh U I	L ₁ , I L ₂ , I L ₃ , I	c		W var VA
Displayed values	row 1	imported harmonic active energy ¹	Uh1n* %	exported harmonic active energy ¹	Uh1n* %	cosinusφ ₁	year	P _{3phase 1}
	row 2		Uh2n* % ¹		Uh2n* % ¹	cosinusφ _{2 1}	month	Q _{3phase 1}
	row 3		Uh3n* % ¹		Uh3n* % ¹	cosinusφ _{3 1}	day	S _{3phase 1}
Displaying		optional						

* Harmonic voltage (current) of L1, L2, L3 phases for n-harmonic

Displayed quantities in the field 8 (fig. 4.)

Table 1b

Displayed symbols	3L, A	A	3L, W	3L, var	3L, VA	3L, PF	3L, tg	3L, W _{AVG}
Displayed values in the row 4	I _{mean 3phase} ¹	I(N) ¹	P _{3phase} ¹	Q _{3phase} ¹	S _{3phase} ¹	PF _{mean 3phase} ¹	tg _{mean 3phase} ¹	P _{3phase (15, 30 or 60 min)} ²
Displaying	optional							



Backlit symbols	3L, c		Hz	%	3L, THD U	3L, THD I
Displayed values in the row 4	cosinus(φ) _{3phase} ¹	hour : minutes	frequency	Consumption of ordered power (in 15, 30 or 60 minutes' time) ²	U _{hmean V/ THD U_{mean U}} ¹	I _{hmean A/ THD I_{mean U}} ¹
Displaying	optional					

In 1Ph/2W measurement mode:

- 1 - values are not calculated and not displayed,
- 2 - values calculated as corresponding values of first phase

Displayed quantities in the field 9 (fig. 4.) for 3-phase 3-wire measurement mode 3Ph/3W and single-phase 1Ph/2W are presented in the table 2a and 2b.

Table 2a

Backlit symbols		L ₁₋₂ , V L ₂₋₃ , V L ₃₋₁ , V	L ₁ , A L ₂ , A L ₃ , A	kWh	-, kWh	 kvar	 kvar
Displayed values	row 1	U12	I1	imported active energy	exported active energy	reactive inductive energy / reactive positive energy	reactive capacitive energy / reactive negative energy
	row 2	U23	I2				
	row 3	U31	I3				
Displaying		optional					

Displayed symbols			W var VA
Displayed values	row 1	year	P _{3phase}
	row 2	month	Q _{3phase}
	row 3	day	S _{3phase}
Displaying		optional	

Displayed quantities in the field 8 (fig. 4.)

Table 2b

Displayed symbols	3L, A	3L, W	3L, var	3L, VA	3L, PF	3L, tg	3L, W _{AVG}
Displayed values in the row 4	I _{mean 3phase}	P _{3phase}	Q _{3phase}	S _{3phase}	PF _{mean 3phase}	t _{gmean 3phase}	P _{3phase (15, 30 or 60 min)}
Displaying	optional						

Backlit symbols	3L, c		Hz	%
Displayed values in the row 4	cosinus(Φ) _{3phase}	hour : minutes	frequency	Consumption of ordered power (in 15, 30 or 60 minutes' time)
Displaying	optional			

Performed calculations:

Reactive power (the calculation method configured):

$$Q = \sqrt{S^2 - P^2}$$

$$\text{or } Q = \sum_{i=1}^k U_i * I_i * \sin(\angle U_i, I_i)$$

where k – harmonic number ($k = 21$ dla 50 Hz, $k = 18$ dla 60 Hz)

Power factor PF: $PF = P / S$

Tangens power: $tg\varphi = Q / P$

Cosinus: cosinus between U and I

The exceeding of the upper indication range is signaled on the display by upper horizontal lines, however the exceeding of the lower range is signaled by lower horizontal lines.

In case of averaged power measurement $P_{3\text{-phase}}$, single measurements are carried out with a 15 seconds' quantum. Suitably to the 15 min, 30 min, 60 min selection, 60, 120 or 240 measurements are averaged. After starting the meter or the power erasing, the first value will be calculated after 15 seconds since the meter switching on or erasing. Till the time to obtain all active power samples, the value of averaged power is calculated from already measured samples.

The current in the neutral wire $I_{(N)}$ is calculated from phase current vectors

The value of consumed ordered power can be used for a previous warning against the exceeding of ordered power and to escape of fines related with it. The consumption of ordered power is calculated on the base of time interval set for the synchronization of the mean active power and the value of ordered power (section 6.5.1). The consumption example is presented in the section 6.5.3.

The alarm switching on is signaled by the lighting of the AL1 inscription (in the mode A3non, A3nof, A3_on, A3_of: of AL1, AL2, AL3 inscriptions). The end of alarm duration at the alarm signaling support switched on, is indicated by the pulsation of the AL1 inscription (in the mode A3non, A3nof, A3_on, A3_of: of AL1, AL2, AL3 inscriptions).

6.4 Operating modes

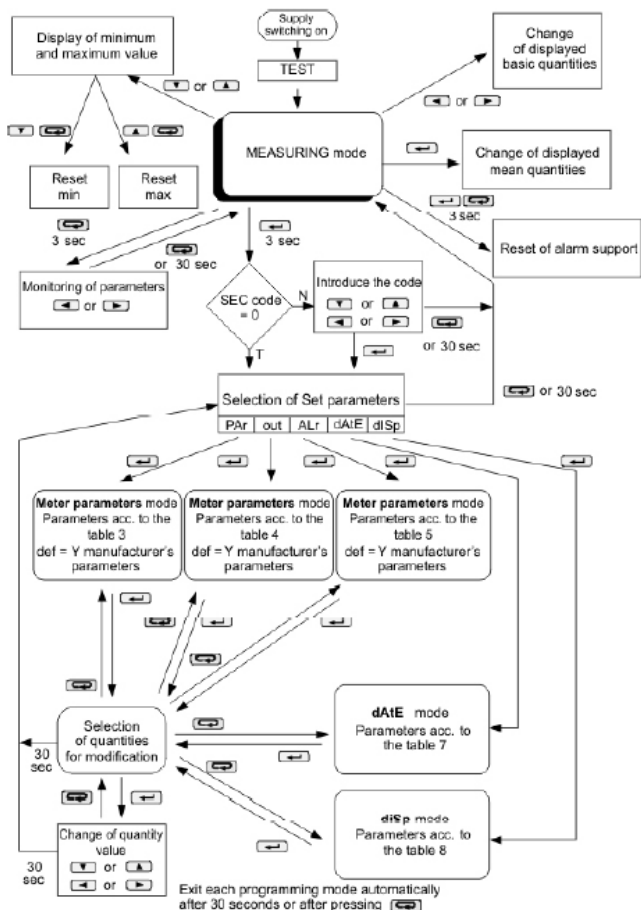

Fig. 6. Operating modes of the ND20 meter.

6.5. Parameter Settings

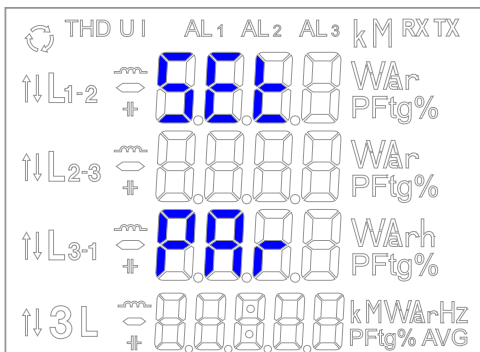



Fig 7. Setup menu

The entry in the programming mode is carried out through the pressure and holding down of the  push-button during ca 3 sec. The entry in the programming mode is protected by the access code. If there is not such a code, the program transits into the programming option. The inscription SET is displayed (in the first row) and the first group of PAR parameters. The monitoring of parameters is always available through the pressure and holding down the  push-button during ca 3 sec.

PRr Meter parameters	SEc Access code	tr-ü Current ratio/voltage ratio	Syn Synchronizing of the active mean power	nHRr Number of the measured harmonic / THD	ELi Scope of the minimum value with errors	g-t Way to the power output	En-g Way to the positive energy	LGht Display backlight	En-D Easing of meters	PR-G Easing of active power	PR-D Easing of the active mean power archive	PRor Ordered power	sonn Type of connection	dEF Meter's parameters
out Output parameters	Rn-n Quantity on the continuous output (table 6 in the manual)	Rn-L Lower value of the input range	Rn-H Higher value of the input range	RnDL Lower value of the output range	RnQH Higher value of the output range	RnEr Mode of work	RnEr Output value when error	Io-n Quantity of impulses	Addr Address in MOEBUS network	tr-yh Transmission mode	bRUd Baud rate	dEF Meter's parameters		
ALr Alarm parameters	RL-n Quantity on the output (table 6 in the user's manual)	RLoF Lower value of the input range	RLon Higher value of the input range	RLde Time delay of the switching reaction	RLS Support of the alarm signaling	RLb Mode of alarm reswitching	dEF Meter's parameters							
dREtE Date and time	t-H Hour, minute	t-d Month, day	t-y Year											
dSP Displayed values	Ü-Ln Phase voltages L-N	Ü-Ll Voltages L-L	Ü-Ln Phase currents	P Phase active powers	g Phase reactive powers	PF Power factors phase	tC Power phase Transients light	EnP Imported active energy	EnP-E Exported active energy	En-g Reactive inductive energy	En-g- Reactive capacitive energy	tHÜJ THD of phase voltages	tHd' THD of phase currents	En-H Imported harmonic energy
	En-H Exported harmonic energy	cos Cosinuses	dREtE Date	P95 P3phase, G3phase, S3phase,	ü-r Three-phase mean current	3P Power 3phase	3R Power 3phase	3S Power 3phase	PF-R Three-phase mean Power Factor PF	tC-R Three-phase mean tangent	PRÜ P3phase (15,30 or 60 minutes)	cosR THD -phase mean Cosinus	HoUr Hour	F-rEg Frequency
	P-or Three-phase ordered power	tH3Ü mean THD of phase voltages	on Display of parameters -ON	off Display of parameters -OFF										

Fig 8. Programming matrix.

6.5.1 Setting of Meter Parameters

Select the **PAr** mode in options (by  or  push-buttons) and approve the choice by the  push-button.







Table 3

Item	Parameter name	Designation	Range	Notes/ description	Manufacturer's value
1	Introduction of the access code	SEc	oFF, 1 ... 60000	0 - without code	0
2	Ratio of the current transformer	tr_I	1 ... 10000		1
3	Ratio of the voltage transformer	tr_U	0.1 ... 4000.0		1
4	Synchronization of mean active power	Syn	15, c_15, c_30, c_60	Synchronization of mean active power: 15 - 15 minutes' walking window (record synchronized with the clock every 15 minutes) c_15 – measurement synchronize with the clock every 15 minutes. c_30 – measurement synchronized with the clock every 30 minutes, c_60 – measurement synchronized with the clock every 60 minutes,	15
5	Number of the measured harmonic/ THD	nHAr	tHd, ALL, 2 ... 21	tHd – THD ALL – successive calculations of harmonics inserted in registers 2...21 – harmonic number (in this mode, the active energy is calculated)	tHd
6	Storage of minimum and maximum values with errors	erLI	oFF, on	oFF – storage of only correct values (from the measuring range). on – storage of also error occurrences in measurements (values in registers 1e20 and 1e20)	on

7	Way to calculate reactive power	q_t	trGLE, SInUS	$\text{TrGLE: } Q = \sqrt{S^2 - P^2}$ $\text{SInUS: } Q = \sum_{k=1}^k U_k * I_k * \sin(\angle U_k, I_k)$ <p>k - harmonic number, k = 21 for 50 Hz, k = 18 for 60 Hz</p>	trGLE
8	Way to calculate reactive energy	En_q	cAP, SIGn	<p>cAP – inductive and capacitive energy</p> <p>SIGn – positive and negative energy</p>	cAP
9	Display backlight	LGht	oFF, 1..60, on	<p>off – disabled, on – enabled, 1..60 – time in seconds of backlight support since the push-button pressure.</p>	on
10	Erasing of watt-hour meters	En 0	no, EnP, Enq, EnH, ALL	<p>no – lack of actions, EnP – erasing of active energy, Enq – erasing of reactive energy, EnH – erasing of harmonic energy. ALL – erasing of all energy</p>	no
11	Erasing of mean active power	PA 0	no, yES	yES -erasing of power	no
12	Reset of mean active power archive	PAr0	no, yES	yES - erasing of archive	no
13	Ordered power	PAor	0...144.0	Ordered power for forecasting the power consumption in % of the rated value	100.0
14	Measurement mode	conn	3Ph-4, 3Ph-3, 1Ph-2	Meter connection way	3Ph-4
15	Manufacturer's parameters	dEf	no, yES	Restoration of manufacturer's parameters of the group.	no

The automatic erasing of energy is carried out:

- for active energy when changing: voltage or current ratio;
- for reactive energy when changing: voltage or current ratio, the way of reactive power calculation;
- for energy of harmonics when changing: voltage or current ratio, when changing the measured harmonic number.

Values are set by means of  and  push-buttons, however the position of the set digit is selected by means of  and  push-buttons. The active position is signaled by the cursor. The value is accepted by  the push-button and resigned by the pressure of the  push-button. During the acceptance, the value insertion possibility in the range is checked. In case when the value is set beyond the range, the meter remains in the parameter edition mode, however the value is set on the maximum value (when the value is too higher) or on the minimum value (when the value is too lower).

6.5.2. Setting of Output Parameters

Select the **out** mode in options and approve the choice by the  push-button.

Table 4

Item	Parameter name	Designation	Range	Notes/description	Manufacturer's value
1	Quantity on the continuous output (code acc. to the table 6)	An_n	table 6	(the code acc. to the table 6)	P
2	Type of continuous output	An_t	0_20, 4_20	The selection 4_20 causes the switching on of the minimum output current limitation on the level ca 3.8 mA.	0_20
3	Lower value of the input range	AnL	-144.0 ... 144.0	in % of the rated quantity value	0
4	Upper value of the input range	AnH	-144.0 ... 144.0	in % of the rated quantity value	100.0
5	Lower value of the output range	AnOL	0.00 ... 24.00	in mA	0
6	Upper value of the output range	AnOH	0.00 ... 24.00	in mA	20

7	Output operation mode	Antr	nor, AnOL, AnOH	Operating mode of the continuous output: nor – normal work, AnOL – set value AnOL, AnOH – set value AnOH,	nor
8	Output value at error	AnEr	0 ... 24	in mA	24
9	Number of impulses	Io_n	1000...20000	Number of impulses for 1 kWh	5000
10	Address in MODBUS network	Addr	1 ... 247		1
11	Transmission mode	trYb	r8n2, r8E1, r8o1, r8n1		8n2
12	Baud rate	bAUd	4.8 k, 9.6 k, 19.2 k, 38.4 k		9,6 k
13	Manufacturer's parameters	dEf	no, yES	Restoration of manufacturer's parameters of the group	no

6.5.3. Setting of Alarm Parameters



Select the **ALr** mode in options and approve the choice by the  push-button.

Table 5

Item	Parameter name	Designation	Range	Notes/description	Manufacturer's value
1	Quantity in the alarm output (code acc. to the table 6)	AL_n	table 6		P
2	Alarm type	AL_t	n-on, n-oFF, on, oFF, H-on, H-oFF, A3non, A3nof, A3_on, A3_of	Fig. 9	n-on

3	Lower value of the input range	ALoF	-144.0 ... 144.0	in % of the rated quantity value	99
4	Upper value of the input range	ALon	-144.0 ... 144.0	in % of the rated quantity value	101
5	Time delay of the switching reaction	ALdt	0 ... 900	in seconds (for quantities AL_n = P_ord the delay occurs only when switching the alarm on)	0
6	Support of the alarm occurrence signaling	AL_S	oFF, on	In the situation when the support function is enabled, after the retreat of the alarm state the alarm symbol is not blanked but begins to pulsate. The signaling exists till the moment of blanking it by means of the  and  push-buttons combination (during 3 seconds). The function concerns only and exclusively the alarm signaling, then relay contacts will be active without support, acc. to the selected type of alarm.	oFF
7	Interlocking of a renewed alarm switching on	AL_b	0...900	in seconds	0
8	Manufacturer's parameters	dEF	no, yES	Restoration of manufacturer's parameters of the group.	no

The write of the value ALon lower than ALoF switches the alarm off.

Selection of the monitored value:

Table 6

Item/ value in re- gister 4015	Di- splay- ed para- meter	Kind of quantity	Value for the percentage conversion of alarm valu- es and outputs (100%)
00	off	lack of quantity /alarm disabled/	none
01	U_1	voltage of phase L1	$U_n [V]^*$
02	I_1	current in the phase wire L1	$I_n [A]^*$
03	P_1	active power of phase L1	$U_n \times I_n \times \cos(0^\circ) [W]^*$
04	q_1	reactive power of phase L1	$U_n \times I_n \times \sin(90^\circ) [var]^*$
05	S_1	apparent power of phase L1	$U_n \times I_n [VA]^*$
06	PF1	active power factor PF of phase L1	1
07	tg1	$\text{tg}\phi$ coefficient of phase L1	1
08	U_2	voltage of phase L2	$U_n [V]^*$
09	I_2	current in the phase wire L2	$I_n [A]^*$
10	P_2	active power of phase L2	$U_n \times I_n \times \cos(0^\circ) [W]^*$
11	q_2	reactive power of phase L2	$U_n \times I_n \times \sin(90^\circ) [var]^*$
12	S_2	apparent power of phase L2	$U_n \times I_n [VA]^*$
13	PF2	active power factor PF of phase L2	1
14	tg2	$\text{tg}\phi$ coefficient of phase L2	1
15	U_3	voltage of phase L3	$U_n [V]^*$
16	I_3	current in the phase wire L3	$I_n [A]^*$
17	P_3	active power of phase L3	$U_n \times I_n \times \cos(0^\circ) [W]^*$
18	q_3	reactive power of phase L3	$U_n \times I_n \times \sin(90^\circ) [var]^*$
19	S_3	apparent power of phase L3	$U_n \times I_n [VA]^*$
20	PF3	active power factor PF of phase L3	1

21	tg3	$\text{tg}\phi$ coefficient of phase L3	1
22	U_A	mean 3-phase voltage	U_n [V] *
23	I_A	mean 3-phase current	I_n [A] *
24	P	3-phase active power (P1 + P2+ P3)	$3 \times U_n \times I_n \times \cos(0^\circ)$ [W] *
25	q	3-phase reactive Power (Q1 + Q2 + Q3)	$3 \times U_n \times I_n \times \sin(90^\circ)$ [var] *
26	S	3-phase apparent Power (S1 + S2 + S3)	$3 \times U_n \times I_n$ [VA] *
27	PF_A	3-phase active power factor PF	1
28	Tg_A	3-phase $\text{tg}\phi$ coefficient	1
29	FrEq	frequency	100 [Hz]
30	U12	phase-to-phase voltage L1-L2	$\sqrt{3} U_n$ [V] *
31	U23	phase-to-phase voltage L2-L3	$\sqrt{3} U_n$ [V] *
32	U31	phase-to-phase voltage L3-L1	$\sqrt{3} U_n$ [V] *
33	U4_A	mean phase-to-phase voltage	$\sqrt{3} U_n$ [V] *
34	P_At	mean active power	$3 \times U_n \times I_n \times \cos(0^\circ)$ [W] *
35	P_ord	Used percentage of the ordered active power (consumed energy)	100%

* U_n, I_n – rated values of voltages and currents

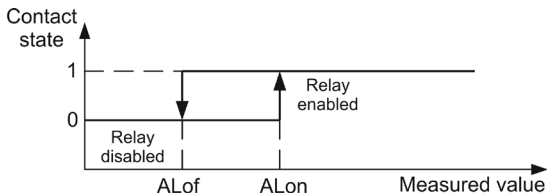

a) n-on

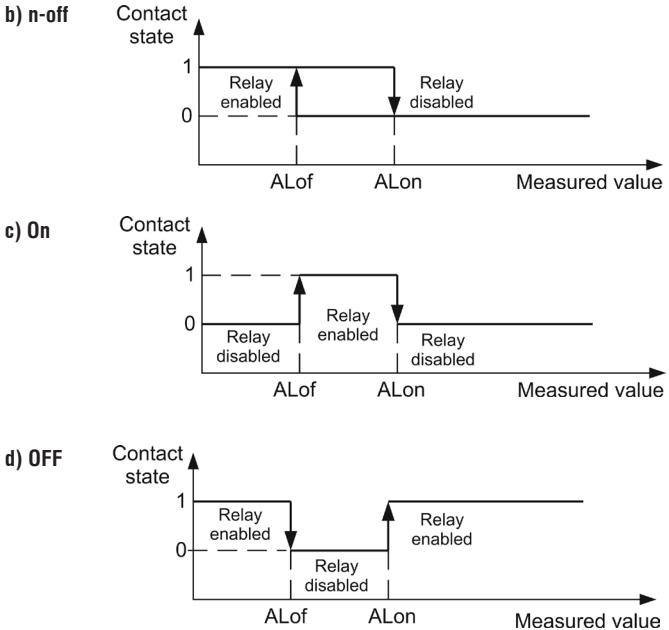



Fig. 9. Alarm types: a),b) normal c) enabled d) disabled

Remaining types of the alarm:

- H-on – always enabled;
- H-off – always disabled,
- A3non – when the “n-on” alarm type occurs on any of the phases – the relay switches on and the corresponding symbol is illuminated (AL1 – phase 1, AL2 – phase 2, AL3 – phase 3). When all alarms fade away, the relay switches off.
- A3nof – when the “n-off” alarm type occurs on any of the phases – the relay switches on and the corresponding symbol is illuminated (AL1 – phase 1, AL2 – phase 2, AL3 – phase 3). When all alarms fade away, the relay switches off.

- A3_on – when the “on” alarm type occurs on any of the phases – the relay switches on and the corresponding symbol is illuminated (AL1 – phase 1, AL2 – phase 2, AL3 – phase 3). When all alarms fade away, the relay switches off.
- A3_of – when the “off” alarm type occurs on any of the phases – the relay switches on and the corresponding symbol is illuminated (AL1 – phase 1, AL2 – phase 2, AL3 – phase 3). When all alarms fade away, the relay switches off

In the “A3” alarm series, the alarm value must range from 0-7. They work with equal ALof and ALon hysteresis thresholds for all of the phases. Signaling sustainment can be switched off by pressing together  and  buttons (for 3 seconds).

Example no 1 of alarm setting:

Set the alarm of n-on type for the monitored quantity P – 3-phase active power, version 5 A; 3 x 230/400 V. Switching the alarm on, after exceeding 3800 W, switching the alarm off after decreasing 3100 W.

Calculate: rated 3-phase active power: $P = 3 \times 230 \text{ V} \times 5 \text{ A} = 3450 \text{ W}$
 $3450 \text{ W} - 100 \%$ $3450 \text{ W} - 100 \%$
 $3800 \text{ W} - \text{ALon} \%$ $3100 \text{ W} - \text{ALoF} \%$

It appears: ALon = 110 % ALoF = 90 %

Set: Monitored quantity: P; Kind of alarm: n-on, ALon 110, ALoF 90.0.

Example no 2 of alarm setting:

Set the alarm of earliest warning about the possibility to exceed the ordered 1 MW power on the level 90% at the one hour accounting. Measuring current transformer 2500/5 A, voltage :230 V, Instantaneous maximum import of power: 1.5 MW.

Calculate: rated 3-phase active power of the ND20 meter: $P = 3 \times 230 \text{ V} \times 2500 \text{ A} (500 * 5 \text{ A}) = 1.725 \text{ MW} (500 * 3450 \text{ W}) - 100\%$;
 $90\% \text{ of ordered power / rated power} = 90.0\% * 1 \text{ MW} / 1.725 \text{ MW} = 52.1 \%$
of the rated meter value (rounding down).

The' ordered hourly power (energy for consumption): 1 MWh / 4 quarters = 900 MWs,

90% - 810 MWs. Remaining 10% at maximum power import would be used in time: $900 \text{ MWs} / 1.5 \text{ MW} = 60 \text{ s}$

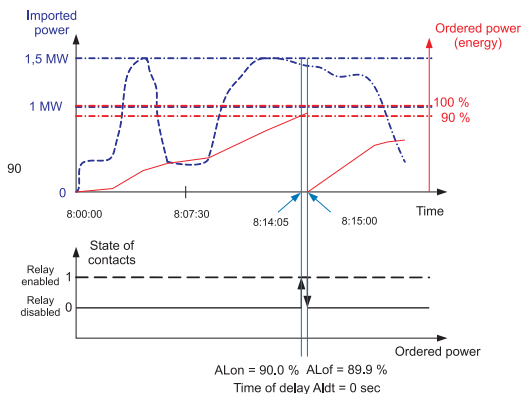

An example of the parameter value utilization of ordered active power to switch the alarm on is presented on the fig. 10.

The time delay is set on 0 sec.

In the calculated example, for remaining 10% of ordered power, at the maximum power consumption, devices could still work during 60 sec without exposing customers to fines. when setting the time delay ALdt on 60 sec, the alarm would not be enabled.

Fig 10. Measurement of 60 minutes' active power consumption synchronized with the clock, with alarm set on a 90% consumption.

Set: Monitored quantity: P_ord, Kind of alarm: n-on, ALon = 90.0, ALof = 89.9, Tr_1 = 500, Syn = c_60, Time delay ALdt = 0 or 240 s.

6.5.4 Setting Date and Time

Select the **dAtE** mode in options and approve the choice by the  push-button. Seconds are reset after setting hour and minute values.

Table 7

Item	Parameter name	Designation	range	Manufacturer's value
1	Hour, minute	t_H	0 ... 23, 0 ... 59	0.00
2	Month, day	t_d	1 ... 12, 1 ... 31	1.01
3	Year	t_y	2001 ... 2100	2001

6.5.5. Setting of displayed values

Select the **DISP** mode in options and approve the choice by the  push-button.

Table 7

No.	Parameter name	Designation	Range	Manufacturer's value
Displayed parameters in the row 1 - 3				
1	Phase voltages	U_Ln	oFF, on	on
2	Phase-to-phase voltages	U_LL	oFF, on	on
3	Phase currents	I_Ln	oFF, on	on
4	Active phase powers	P	oFF, on	on
5	Reactive phase powers	q	oFF, on	on
6	Apparent phase powers	S	oFF, on	on
7	Phase PF power factors	PF	oFF, on	on
8	Phase Tangents φ factors	tG	oFF, on	on
9	Input active energy	EnP	oFF, on	on
10	Output active energy	EnP-	oFF, on	on
11	Inductive reactive energy	Enq	oFF, on	on
12	Capacity reactive energy	Enq-	oFF, on	on
13	THD of phase voltage	tHdu	oFF, on	on
14	THD of phase current	tHdl	oFF, on	on
15	Harmonic input active energy	EnH	oFF, on	on
16	Harmonic output active energy	EnH-	oFF, on	on
17	Phase Cosinus φ	cos	oFF, on	on
18	Date	date	oFF, on	on

19	3-phase active, reactive, apparent power	PqS	oFF, on	on
Displayed parameters in the row 4				
20	Three-phase mean current	I_A	oFF, on	on
21	Current in neutral wire	I_n	oFF, on	on
22	Three-phase active power	3P	oFF, on	on
23	Three-phase reactive power	3q	oFF, on	on
24	Three-phase apparent power	3S	oFF, on	on
25	Three-phase mean power factor PF	PF_A	oFF, on	on
26	Three-phase mean Tangent φ factor	tG_A	oFF, on	on
27	Three-phase mean active power (15,30 or 60 minutes)	PAvG	oFF, on	on
28	Three-phase mean Cosinus φ	coSA	oFF, on	on
29	Hour	HoUr	oFF, on	on
30	Frequency	Freq	oFF, on	on
31	Three-phase ordered power	p_or	oFF, on	on
32	Mean THD of phase voltages	tH3U	oFF, on	on
33	Mean THD of phase currents	tH3I	oFF, on	on
34	Diplay of parameters - ON	on	no, YES	no
35	Display of parameters - OFF	off	no, YES	no

Note! When you turn off the display of all parameters, the phase current values and three-phase mean current are displayed.

6.6. Configuration of THD Measurement, Harmonics and Energy for the Harmonic

The meter has 3 work modes related to the THD and harmonic calculation. When setting the parameter of the harmonic number:

- tHd – the meter measures every 1 second only the THD value for currents and voltages, the result is exposed on the display and expressed in registers in percentages. Energy of harmonics is reset and particular harmonics include the error value (1e20);

- All – the meter measures harmonics from 2 up to 21, for 50 Hz frequency (from 2 up to 18 for 60 Hz frequency). Energy of harmonics is reset.

- 2 – 21 – measurement of the selected harmonic value, every 1 second, the result is exposed on the display and in basic units (V, A) in registers. Energy for the given harmonic is counted up.

The switching of the harmonic number or the change of voltage or current ratio resets energy for harmonics.

6.7. Archive – Active Power Profile

The ND20 meter is equipped with an archive allowing to store up to 9000 measurements of mean active power. Mean active power PAV is archived with a 15, 30, 60 minutes' interval of time, synchronized with the real time clock. In case of operation in the 15 minutes' walking window mode, the archiving is performed in the same way as for the 15 minutes' interval of time (fig. 11). The direct access to the archive is for 15 records including the date, time and value placed in the range of addresses 1000 -1077. The position of the first (oldest) archived sample is placed in the register 1000, however the position of the last archived sample (youngest) is placed in the register 1001. the value of the first record, from 15 available records placed in registers 1003 – 1077, is written in the register 1002. The write of the first read out record value (1 – 9000) causes the data updating of 15 records for readout.

In registers, in which samples were not already been written, are 1e20 values.

The archive is organized in the shape of a circular buffer. After writing the 9000 th value, the next overwrites the oldest with number 0, and the successive, the next with number 1, etc.

If the value of the register 1000 is higher than 1001, that means that the buffer was overflowed one time at least. Eg, the value 15 in the register 1000, and 14 in the register 1001 means, that there were already more than nine thousand samples and oldest samples are from the record 15 up to 9000, next from the record 1 to the youngest record with number 14.

The change of the current or voltage ratio, kind of mean power, causes the archive erasing.

The reset of averaged power or the change of averaging time does not erase the archive.

The automatic erasing of the archive and averaged power is performed when changing the voltage or current ratio.

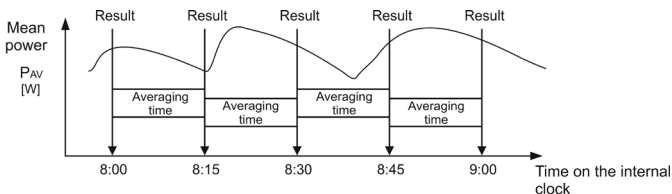
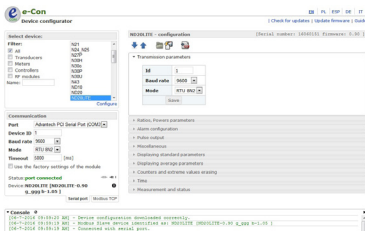

Fig. 11. Measurement of 15 minutes' mean active power synchronized with the clock.

7. UPDATING OF SOFTWARE

Function enabling updating of software from the computer of the PC with software eCon was implementation in meter ND20 (from software version 1.09). Free software eCon and update files are accessible on the site www.ditel.es The connected to the computer converter RS485 is required on USB to the updating,

a)



b)

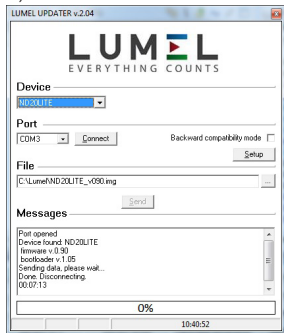



Fig. 13. Program view: a) eCon, b) updating of software

Note! After updating the software, the manufacturer's settings of the meter should be set, so it is recommended to save the meter parameters before updating using the software eCon.

After starting eCon's software COM port, baudrate, transmission mode and address should be set. It can be done in *Options*. Then, ND20 meter should be selected from *Device*. Push icon *Load* to read and save current settings. Open window *Lumel Updater (LU)* – figure 13b from *Updating->Updating of devices firmware*. Push *Connect*. Update progress is shown in *Messages* section. Text *Port opened* appear after correctly opened port. Putting meter in update's mode can be done in two ways: remote from LU (with settings from eCon – port, baudrate, transmission mode and address) or by turning power on while  button pressed. Meter display shows the „boot“ inscription with bootloader version, LU shows message „*Device found*“ with name and current version of firmware. Using button  browse to the meter upgrade file. If the file is opened correctly, a *File opened* message is displayed. Press the *Send* button. When upgrade is successfully completed, meter reverts to the default settings and begins normal operation while the information window displays *Done* message and upgrade elapsed time. Close LU and go to *Restoration of default parameters*. Select checkbox and press *Apply* button. After the LU window is closed, press the *Save* icon to save all initially read parameters. Current firmware version can be checked when meter is power on.

Warning! Turning the meter off during upgrade process may result in permanent damage!

8. RS-485 INTERFACE

The implemented protocol is compliant with the PI-MBUS-300 Rev G, Modicon. Parameter set of the serial ND20 meter link:

- identifier 0xBC
- meter address: 1..247
- baud rate 4.8, 9.6, 19.2, 38.4 kbit/s,
- working mode Modbus RTU,
- information unit 8N2, 8E1, 8O1, 8N1,
- maximum response time 600 ms.
- maximum quantity of read out registers in one request
 - 41 registers – 4 byte registers,
 - 82 registers – 2 byte registers,
- implemented functions 03, 04, 06, 16, 17,
 - 03, 04 - readout of registers,
 - 06 - write of one register,
 - 16 - write of n-registers,
 - 17 - device identification,

Manufacturer's settings: address 1, baud rate: 9600 baud, RTU 8N2 mode,

Readout of n-registers (code 03h)

Example 1 . Readout of 2 registers 16-bit of integer type, starting with the register with the 0FA0h (4000) address - register values 10, 100.

Request:

Device address	Function	Register address		Number of registers		CRC Control sum
		B1	B0	B1	B0	
01	03	0F	A0	00	02	C7 3D

Response:

Device address	Function	Number of bytes	Register address 0FA0 (4000)		Number of registers 0FA1 (4001)		CRC Control sum
			B1	B0	B1	B0	
01	03	04	00	0A	00	64	E4 6F

Example 2 . Readout of 2 registers 32-bit of float type as 2 registers 16-bits, starting with the register with the 1B58h (7000) address - register values 10, 100.

Request:

Device address	Function	Register address		Number of registers		CRC Control sum
		B1	B0	B1	B0	
01	03	1B	58	00	04	C3 3E

Response:

Device address	Function	Number of bytes	Value from register 1B58 (7000)		Value from register 1B59 (7001)		Value from register 1B5A (7002)		Value from register 1B5B (7003)		CRC Control sum
			B3	B2	B1	B0	B3	B2	B1	B0	
01	03	08	41	20	00	00	42	C8	00	00	E4 6F

Example 3 . Readout of 2 registers 32-bit of float type as 2 registers 16-bit, starting with the register with the 1770h (6000) address - register values 10, 100.

Request

Device address	Function	Register address		Number of registers		CRC Control sum
		B1	B0	B1	B0	
01	03	17	70	00	04	4066

Response:

Device address	Function	Number of bytes	Value from register 1770h (6000)		Value from register 1770h (6000)		Value from register 1772h (6002)		Value from register 1772h (6002)		CRC Control sum
			B1	B0	B3	B2	B1	B0	B3	B2	
01	03	08	00	00	41	20	00	00	42	C8	E4 6F

Example 4 . Readout of 2 registers 32-bit of float type, starting with the register with the 1D4Ch (7500) address - register values 10, 100.

Request:

Device address	Function	Register address		Number of registers		CRC Control sum
		B1	B0	B1	B0	
01	03	1D	4C	00	02	03 B0

Response:

Device address	Function	Number of bytes	Value from register 1D4C (7500)				Value from register 1D4D (7501)				CRC Control sum
			B3	B2	B1	B0	B3	B2	B1	B0	
01	03	08	41	20	00	00	42	C8	00	00	E4 6F

Recording a single register (code 06h)

Example 5 . Recording the value 543 (0x021F) in the register 4000 (0x0FA0)

Request:

Device address	Function	Register address		Number of registers		CRC Control sum
		B1	B0	B1	B0	
01	06	0F	A0	02	1F	CA 54

Response:

Device address	Function	Register address		Number of registers		CRC Control sum
		B1	B0	B1	B0	
01	06	0F	A0	02	1F	CA 54

Recording to n-registers (code 10h)

Example 6 . Recording 2 registers starting with the register with the 0FA3h (4003) address recorded values 20, 2000.

Request:

Device address	Function	Register addr. Hi	Register addr. Lo	Register addr. Hi	Register addr. Lo	Number of bytes	Value for register 0FA3 (4003)		Value for register 0FA4 (4004)		CRC Control sum
							B1	B0	B1	B0	
01	10	0F	A3	00	02	04	00	14	07	D0	BB 9A

Response:

Device address	Function	Register address		Number of registers		CRC Control sum
		B1	B0	B1	B0	
01	10	0F	A3	00	02	B2 FE

Report identifying the device (code 11h)

Example 7 . Device identification

Request: Table 8

Device address	Function	CRC Control sum
01	11	C0 2C

Response:

Device address	Function	Number of bytes	Identifier	Device status	Information field of the device software version (eg, „ND20-1.09 b-1.04” - ND20 device with software version 1.09 and bootloader version 1.04)	CRC Control sum
01	11	19	BC	FF	4E 44 32 30 2D 31 2E 30 39 20 20 20 20 20 20 20 62 2D 31 2E 30 34 20	DB 42

Map of ND20 meter registers

In the ND20 meter, data are placed in 16 and 32-bit registers. Process variables and meter parameters are placed in the address area of registers in a way depended on the variable value type. Bits in 16-bit registers are numbered from the youngest to the oldest (b0-b15). 32-bit registers include numbers of float type in IEEE-754 standard.

Table 9

Address range	Type of value	Description
1000 – 1077	Integer (16 bits)/ record	Archive of the averaged power profile. The table 10 includes the register description.
4000 – 4055	Integer (16 bits)	The value is placed in one 16-bit register. The table 11 includes the register description. Registers for write and readout.
6000 – 6319	Float (2x 16 bits)	Value placed in two successive 16-bit registers. Registers include the same data as 32-bit registers from the area 7500 – 7659. Registers for readout. Sequence of bytes (1-0-3-2).
6320 – 6573	Float (2x 16 bits)	Value placed in two successive 16-bit registers. Registers include the same data as 32-bit registers from the area 7660 – 7786. Registers for readout. Sequence of bytes (1-0-3-2).

7000 – 7319	Float (2x16 bits)	Value placed in two successive 16-bit registers. Registers include the same data as 32-bit registers from the area 7500 – 7659. Registers for readout. Sequence of bytes (3-2-1-0).
7500 – 7659	Float (32 bits)	Value placed in one 32-bit register. The table 12 includes the register description. Registers for readout.
7660 – 7786	Float (32 bits)	Value placed in one 32-bit register. The table 12 includes the register description. Registers for readout.
7800 – 8052	Float (2x16 bits)	Value placed in two successive 16-bit registers. Registers include the same data as 32-bit registers from the area 7660 – 7786. Registers for readout. Sequence of bytes (3-2-1-0).

Table 10

Address of 16 bit-registers	Operations	Description
1000	R	Position of oldest archived mean power.
1001	R	Position of youngest archived mean power
1002	R/W	First available record – NrBL (range 1...9000)
1003	R	Year of archived mean power with number NrBL + 0
1004	R	Month * 100 + day of archived mean power with number NrBL + 0
1005	R	Hour * 100 + minute of archived mean power with number NrBL + 0
1006	R	Value of archived mean power with number NrBL + 0 float type – 4 bytes in sequence 3-2-1-0
1007	R	
1008	R	Year of archived mean power with number NrBL + 1
1009	R	Month * 100 + day of archived mean power with number NrBL + 1

1010	R	Hour * 100 + minute of archived mean power with number NrBL + 1
1011	R	Value of archived mean power with number NrBL + 1 float type – 4 bytes in sequence 3-2-1-0
1012	R	
...
1073	R	Year of archived mean power with number NrBL + 14
1074	R	Month * 100 + day of archived mean power with number NrBL + 14
1075	R	Hour * 100 + minute of archived mean power with number NrBL + 14
1076	R	Value of archived mean power with number NrBL + 14 float type – 4 bytes in sequence 3-2-1-0
1077	R	

Table 11

Register address	Operation	Range	Description	By default
4000	RW	0...60000	Protection - password	0
4001	RW	0...900 [s]	Interlocking time of the renewed switching of the relay output on	0
4002	RW	0...1440 [‰]	Ordered mean power *10	1000
4003	RW	1..10000	Current transformer ratio	1
4004	RW	1..40000	Voltage transformer ratio *10	10

4005	RW	0..3	<p>Synchronization of mean active power:</p> <p>0 – 15 minutes' walking window (record synchronized every 15 minutes with the clock)</p> <p>1 – measurement synchronized every 15 minutes with the clock</p> <p>2 – measurement synchronized every 30 minutes with the clock</p> <p>3 – measurement synchronized every 60minutes with the clock</p>	0
4006	RW	0..22	<p>Number of the measured harmonic/ THD</p> <p>0 – THD,</p> <p>1 – all harmonics are successively measured and placed in registers 7660-7780, 2...21 – harmonic number with energy.</p>	0
4007	RW	0,1	<p>Storage way of minimum and maximum values</p> <p>0 – without errors,</p> <p>1 – with errors</p>	0
4008	RW	0,1	<p>Way to calculate reactive power:</p> <p>0: $Q = \sqrt{S^2 - P^2}$</p> <p>1: $Q = \sum_{i=1}^k U_i * I_i * \sin(\angle U_i, I_i)$</p> <p>k – harmonic number, k = 21 for 50 Hz, k = 18 for 60 Hz</p>	0
4009	RW	0,1	<p>Way to calculate reactive energy:</p> <p>0 – inductive and capacitive energy</p> <p>1 – positive and negative energy</p>	0
4010	RW	0...61	<p>Display backlight:</p> <p>0 – disabled,</p> <p>1-60 – backlight time in seconds since the push-button pressure,</p> <p>61 – always enabled</p>	61

4011	RW	0...4	Erasing of watt-hour meters: 0 – without changes, 1 - erase active energy, 2 – erase reactive energy, 3 – erase energy of harmonics, 4 – erase all energy.	0
4012	RW	0,1	Erasing of mean active power P_{AV}	0
4013	RW	0,1	Erasing of the averaged power archive	0
4014	RW	0,1	Erase min and max	0
4015	RW	0,1 .. 35	Quantity on the alarm relay output (code acc. to the table 6)	24
4016	RW	0 ... 9	Output type: 0 – n-on, 1– n-off, 2 – on, 3 - oFF, 4 – H-on, 5 – H-off, 6 - A3non, 7 - A3nof, 8 - A3_on, 9 - A3_of	0
4017	RW	-1440..0.. 1440 [‰]	Lower alarm switching value	990
4018	RW	-1440..0.. 1440 [‰]	Upper alarm switching value	1010
4019	RW	0...900 s	Delay of the alarm switching (for quantity $AL_n = P_{ord} - rgister$ 4015 =35, the delay occurs only when the alarm is switched on.	0
4020	RW	1..2000 [10uA]	Alarm signaling support	0
4021	RW	0..2	Quantity on the continuous output no 1/ code acc. to the table 6 /	24
4022	RW	0,1	Continuous output type: 0 – 0...20 mA; 1 – 4...20 mA	0
4023	RW	-1440..0.. 1440 [‰]	Lower value of the input range in [‰] of the rated input range.	0
4024	RW	-1440..0.. 1440 [‰]	Upper value of the input range in [‰] of the rated input range.	1000

4025	RW	-2000..0.. 2000 [10uA]	Lower output range value of the output [10 uA]	0
4026	RW	1..2000 [10uA]	Upper output range value of the output [10 uA]	2000
4027	RW	0..2	Manual switching of the analog output 1: 0 – normal work, 1 – set value from the register 4026, 2- set value from the register 4027,	0
4028	RW	0..24 [mA]	Analog output value when error	24
4029	RW	1000.. 20000	Number of impulses for the impulse output	5000
4030	RW	1..247	Address in the MODBUS network	1
4031	RW	0..3	Transmission mode: : 0->r8n2, 1->r8E1, 2->r8o1, 3->r8n1	0
4032	RW	0..3	Baud rate: 0->4800, 1->9600 2->19200, 3->38400	1
4033	RW	0.1	Bring up to date the transmission parameter change	0
4034	RW	0..2359	Hour *100 + Minutes	0
4035	RW	101.. 1231	Month * 100 + day	101
4036	RW	2009.. 2100	Year	2009
4037	RW	0,1	Record of standard parameters (together with the reset of energy and min, max, averaged power)	0
4038	R	0..15258	Imported active energy, two older bytes	0
4039	R	0.. 65535	Imported active energy, two younger bytes	0

4040	R	0..15258	Exported active energy, two older bytes	0
4041	R	0..65535	exported active energy, two younger bytes	0
4042	R	0..15258	Reactive inductive energy, two older bytes	0
4043	R	0..65535	Reactive inductive energy, two younger bytes	0
4044	R	0..15258	Reactive capacitive energy, two older bytes	
4045	R	0..65535	Reactive capacitive energy, two younger bytes	0
4046	R	0..15258	Imported harmonic active energy, two older bytes	0
4047	R	0..65535	Imported harmonic active energy, two younger bytes	0
4048	R	0..15258	Exported harmonic active energy, two older bytes	0
4049	R	0..65535	Exported harmonic active energy, two younger bytes	0
4050	R	0..65535	Status register – description below	0
4051	R	0..65535	Serial number, two older bytes	-
4052	R	0..65535	Serial number, two younger bytes	-
4053	R	0..65535	Program version (*100)	-
4054	RW	0..65535	Displayed parameters of standard values	0xFFFF
4055	RW	0..65535	Displayed parameters of average values	0xFFFF
4056*	RW	0..65535	Displayed parameters of standard values 2	0xFFFF
4057*	RW	0...2	Measurement mode: 0->3Ph / 4W, 1->3Ph / 4W 2-> 1Ph/2W	0
4058*	R	0..65535	reserved	0

4059*	R	0..65535	reserved	0
4060*	R	0..65535	reserved	0
4061*	R	0..65535	Register of status 2 - description below	0

In parenthesis [], suitably is placed: resolution or unit.

* starting from version 1.09

Energy is made available in hundreds of watt-hours (var-hours) in double 16-bit register, and for this reason, one must divide them by 10 when calculating values of particular energy from registers, ie:

Imported active energy = (register 4038 value x 65536 + register 4039 value) /10 [kWh]

Exported active energy = (register 4040 value x 65536 + register 4041 value) /10 [kWh]

Reactive inductive energy = (register 4042 value x 65536 + register 4043 value) /10 [kVarh]

Reactive capacitive energy = (register 4044 value x 65536 + register 4045 value) /10 [kVarh]

Imported active harmonic energy = (register 4046 value x 65536 + register 4047 value) /10 [kWh]

Exported active harmonic energy = (register 4048 value x 65536 + register 4049 value) / 10 [kWh]

Device status register (address 4050, R):

Bit 15 – „1” – damage of the non-volatile memory

Bit 7 – „1” – the interval of averaged power is not elapsed

Bit 14 – „1” – lack of calibration or erroneous calibration

Bit 6 – „1” – frequency for THD calculation beyond intervals
- 48 – 52 for frequency 50 Hz,
- 58 – 62 for frequency 60 Hz

Bit 13 – „1” – error of parameter values

Bit 5 – „1” – voltage too low for frequency measurements

Bit 12 – „1” – error of energy values

Bit 4 – „1” – too low voltage of phase C

Bit 11 – „1” – error of phase sequence

Bit 3 – „1” – too low voltage of phase B

Bit 10 – current range „0” – 1 A~; „1” – 5 A~

Bit 2 – „1” – too low voltage of phase A

Bit 9 Bit 8 Voltage range

Bit 1 – the RTC time battery is used up

0 0 57.7 V~

Bit 0 – state of relay output „1” – On,

0 1 230 V~

„0” - off

Register of status 2 - nature of the reactive power (address 4061, R):

Bit 15 – reserved	Bit 9 – „1” – capacitive 3L
Bit 14 – „1” – alarm indication in phase L3 (only for alarm type: A3non, A3nof, A3_on, A3_of)	Bit 8 – „1” – capacitive L3 maximum
Bit 13 – „1” – alarm indication in phase L2 (only for alarm type: A3non, A3nof, A3_on, A3_of)	Bit 7 – „1” – capacitive L3 minimum
Bit 12 – „1” – alarm indication in phase L1 (only for alarm type: n-on, n-off, on, off)	Bit 6 – „1” – capacitive L3
Bit 11 – „1” – capacitive 3L maximum	Bit 5 – „1” – capacitive L2 maximum
Bit 10 – „1” – capacitive 3L minimum	Bit 4 – „1” – capacitive L2 minimum
	Bit 3 – „1” – capacitive L2
	Bit 2 – „1” – capacitive L1 maximum
	Bit 1 – „1” – capacitive L1 minimum
	Bit 0 – „1” – capacitive L1

Configuration register of displayed parameters of standard values (address 4054, R/W):

Bit 15 ...13 – reserved	Bit 6 – „1” – displaying of capacitive passive energy
Bit 12 – „1” – displaying of the date	Bit 5 – „1” – displaying of inductive passive energy
Bit 11 – „1” – displaying of the cosine φ values	Bit 4 – „1” – displaying of exported active energy
Bit 10 – „1” – displaying of active exported harmonic energy/ value of current harmonic	Bit 3 – „1” – displaying of imported active energy
Bit 9 – „1” – displaying of active imported harmonic energy/ value of voltage harmonic	Bit 2 – „1” – displaying of tg
Bit 8 – „1” – displaying of THD current/ value of current harmonic	Bit 1 – „1” – displaying of PF
Bit 7 – „1” – displaying of THD voltage/ value of voltage harmonic	Bit 0 – „1” – displaying of phase-to-phase voltages

Configuration register of displayed parameters of standard values 2
(address 4056, R/W):

Bit 15 ...6 – reserved	Bit 2 – „1” – displaying of phase active powers
Bit 5 – „1” – displaying of power ΣP , ΣQ , ΣS	Bit 1 – „1” – displaying of phase currents
Bit 4 – „1” – displaying of phase apparent powers	Bit 0 – „1” – displaying of phase voltages
Bit 3 – „1” – displaying of phase reactive powers	

Configuration register of displayed parameters of average values
(address 4055, R/W):

Bit 15 ...14 – reserved	Bit 5 – „1” – displaying of time
Bit 13 – „1” – displaying of mean THD of current	Bit 4 – „1” – displaying of average cosine φ
Bit 12 – „1” – displaying of mean THD of voltage	Bit 3 – „1” – displaying of average active power
Bit 11 – „1” – displaying of power ΣS	Bit 2 – „1” – displaying of average tg
Bit 10 – „1” – displaying of power ΣQ	Bit 1 – „1” – displaying of average PF
Bit 9 – „1” – displaying of power ΣP	Bit 0 – „1” – displaying of current in neutral wire
Bit 8 – „1” – displaying of average current	
Bit 7 – „1” – displaying of ordered power consumption	
Bit 6 – „1” – displaying of frequency	

Table 12

Address of 16-bit registers	Address of 32-bit registers	Operation	Description	Unit	3Ph/4W	3Ph/3W	3Ph/2W
6000/7000	7500	R	Voltage of phase L1	V	√	x	√
6002/7002	7501	R	Current in phase L1	A	√	√	√
6004/7004	7502	R	Active power of phase L1	W	√	x	√
6006/7006	7503	R	Reactive power of phase L1	var	√	x	√
6008/7008	7504	R	Apparent power of phase L1	VA	√	x	√
6010/7010	7505	R	Power factor (PF) of phase L1	-	√	x	√
6012/7012	7506	R	Tg ϕ factor of phase L1	-	√	x	√
6014/7014	7507	R	Voltage of phase L2	V	√	x	x
6016/7016	7508	R	Current in phase L2	A	√	√	x
6018/7018	7509	R	Active power of phase L2	W	√	x	x
6020/7020	7510	R	Reactive power of phase L2	var	√	x	x
6022/7022	7511	R	Apparent power of phase L2	VA	√	x	x
6024/7024	7512	R	Power factor (PF) of phase L2	-	√	x	x
6026/7026	7513	R	Tg ϕ factor of phase L2	-	√	x	x
6028/7028	7514	R	Voltage of phase L3	V	√	x	x
6030/7030	7515	R	Current in phase L3	A	√	√	x
6032/7032	7516	R	Active power of phase L3	W	√	x	x
6034/7034	7517	R	Reactive power of phase L3	var	√	x	x
6036/7036	7518	R	Apparent power of phase L3	VA	√	x	x
6038/7038	7519	R	Power factor (PF) of phase L3	-	√	x	x
6040/7040	7520	R	Tg ϕ factor of phase L3	-	√	x	x

6042/7042	7521	R	Mean 3-phase voltage	V	√	x	x
6044/7044	7522	R	Mean 3-phase current	A	√	√	x
6046/7046	7523	R	3-phase active power (P1+P2+P3)	W	√	√	x
6048/7048	7524	R	3-phase reactive power (Q1+Q2+Q3)	var	√	√	x
6050/7050	7525	R	3-phase apparent power (S1+S2+S3)	VA	√	√	x
6052/7052	7526	R	Mean power factor (PF)	-	√	√	x
6054/7054	7527	R	Mean $Tg \phi$ factor of phase L1	-	√	√	x
6056/7056	7528	R	Frequency	Hz	√	√	x
6058/7058	7529	R	Phase-to-phase voltage L1-2	V	√	√	x
6060/7060	7530	R	Phase-to-phase voltage L2-3	V	√	√	x
6062/7062	7531	R	Phase-to-phase voltage L3-1	V	√	√	x
6064/7064	7532	R	Mean phase-to-phase voltage	V	√	√	x
6066/7066	7533	R	3-phase 15, 30, 60 minutes' active Power (P1 + P2 + P3)	W	√	√	√
6068/7068	7534	R	Harmonic U1 / THD U1	V / %	√	x	√
6070/7070	7535	R	Harmonic U2 / THD U2	V / %	√	x	x
6072/7072	7536	R	Harmonic U3 / THD U3	V / %	√	x	x
6074/7074	7537	R	Harmonic I1 / THD I1	A / %	√	x	√
6076/7076	7538	R	Harmonic I2 / THD I2	A / %	√	x	x
6078/7078	7539	R	Harmonic I3 / THD I3	A / %	√	x	x
6080/7080	7540	R	Cosinus of angle between U1 and I1	-	√	x	x
6082/7082	7541	R	Cosinus of angle between U2 and I2	-	√	x	x
6084/7084	7542	R	Cosinus of angle between U3 and I3	-	√	x	x

6086/7086	7543	R	3-phase mean cosinus	-	√	√	x
6088/7088	7544	R	Angle between U1 and I1	°	√	x	√
6090/7090	7545	R	Angle between U2 i I2	°	√	x	x
6092/7092	7546	R	Angle between U3 i I3	°	√	x	x
6094/7094	7547	R	Current in neutral wire (calculated from vectors)	A	√	x	x
6096/7096	7548	R	Imported 3-phase active energy (number of overflows in register 7549, reset after exceeding 99999999.9 kWh)	100 MWh	√	√	P1
6098/7098	7549	R	Imported 3-phase active energy (counter totting up to 99999.9 kWh)	kWh	√	√	P1
6100/7100	7550	R	Exported 3-phase active energy (number of overflows in register 7551, reset after exceeding 99999999.9 kWh)	100 MWh	√	√	P1
6102/7102	7551	R	Exported 3-phase active energy (counter totting up to 99999.9 kWh)	kWh	√	√	P1
6104/7104	7552	R	3-phase reactive inductive energy (number of overflows in register 7553, reset after exceeding 99999999.9 kVarh)	100 Mvarh	√	√	Q1
6106/7106	7553	R	3-phase reactive inductive energy (counter totting up to 99999.9 kVarh)	kvarh	√	√	Q1
6108/7108	7554	R	3-phase reactive capacitive energy (number of overflows in register 7555, reset after exceeding 99999999.9 kVarh)	100 Mvarh	√	√	Q1

6110/7110	7555	R	3-phase reactive capacitive energy (counter totting up to 99999.9 kVarh)	kvarh	√	√	Q1
6112/7112	7556	R	Imported 3-phase active harmonic energy (number of overflows in register 7557, reset after exceeding 99999999.9 kWh)	100 MWh	√	x	x
6114/7114	7557	R	Imported 3-phase active harmonic energy (counter totting up to 99999.9 kWh)	kWh	√	x	x
6116/7116	7558	R	Exported 3-phase active harmonic energy (number of overflows in register 7559, reset after exceeding 99999999.9 kWh)	100 MWh	√	x	x
6118/7118	7559	R	Exported 3-phase active harmonic energy (counter totting up to 99999.9 kWh)	kWh	√	x	x
6120/7120	7560	R	Time – hours, minutes	-	√	√	√
6122/7122	7561	R	Time – month, day	-	√	√	√
6124/7124	7562	R	Time – year	-	√	√	√
6126/7126	7563	R	Analog output value	mA	√	√	√
6128/7128	7564	R	Voltage L1 min	V	√	x	√
6130/7130	7565	R	Voltage L1 max	V	√	x	√
6132/7132	7566	R	Voltage L2 min	V	√	x	x
6134/7134	7567	R	Voltage L2 max	V	√	x	x
6136/7136	7568	R	Voltage L3 min	V	√	x	x
6138/7138	7569	R	Voltage L3 max	V	√	x	x
6140/7140	7570	R	Current L1 min	A	√	√	√
6142/7142	7571	R	CurrentL1 max	A	√	√	√

6144/7144	7572	R	Current L2 min	A	√	√	x
6146/7146	7573	R	Current L2 max	A	√	√	x
6148/7148	7574	R	Current L3 min	A	√	√	x
6150/7150	7575	R	Current L3 max	A	√	√	x
6152/7152	7576	R	Active power L1 min	W	√	x	√
6154/7154	7577	R	Active power L1 max	W	√	x	√
6156/7156	7578	R	Active power L2 min	W	√	x	x
6158/7158	7579	R	Active power L2 max	W	√	x	x
6160/7160	7580	R	Active power L3 min	W	√	x	x
6162/7162	7581	R	Active power L3 max	W	√	x	x
6162/7164	7582	R	Reactive power L1 min	var	√	x	√
6166/7166	7583	R	Reactive power L1 max	var	√	x	√
6168/7168	7584	R	Reactive power L2 min	var	√	x	x
6170/7170	7585	R	Reactive power L2 max	var	√	x	x
6172/7172	7586	R	Reactive power L3 min	var	√	x	x
6174/7174	7587	R	Reactive power L3 max	var	√	x	x
6176/7176	7588	R	Apparent power L1 min	VA	√	x	√
6178/7178	7589	R	Apparent power L1 max	VA	√	x	√
6180/7180	7590	R	Apparent power L2 min	VA	√	x	x
6182/7182	7591	R	Apparent power L2 max	VA	√	x	x
6184/7184	7592	R	Apparent power L3 min	VA	√	x	x
6186/7186	7593	R	Apparent power L3 max	VA	√	x	x
6188/7188	7594	R	Power factor (PF) of phase L1 min	-	√	x	√
6190/7190	7595	R	Power factor (PF) of phase L1 max	-	√	x	√
6192/7192	7596	R	Power factor (PF) of phase L2 min	-	√	x	x
6194/7194	7597	R	Power factor (PF) of phase L2 max	-	√	x	x
6196/7196	7598	R	Power factor (PF) of phase L3 min	-	√	x	x
6198/7198	7599	R	Power factor (PF) of phase L3 max	-	√	x	x

6200/7200	7600	R	Tg ϕ factor of phase L1 min	-	√	x	√
6202/7202	7601	R	Tg ϕ factor of phase L1 max	-	√	x	√
6204/7204	7602	R	Tg ϕ factor of phase L2 min	-	√	x	x
6206/7206	7603	R	Tg ϕ factor of phase L2 max	-	√	x	x
6208/7208	7604	R	Tg ϕ factor of phase L3 min	-	√	x	x
6210/7210	7605	R	Tg ϕ factor of phase L3 max	-	√	x	x
6212/7212	7606	R	Phase-to-phase voltage L1-2 min	V	√	√	x
6214/7214	7607	R	Phase-to-phase voltage L1-2 max	V	√	√	x
6216/7216	7608	R	Phase-to-phase voltage L2-3 min	V	√	√	x
6218/7218	7609	R	Phase-to-phase voltage L2-3 max	V	√	√	x
6220/7220	7610	R	Phase-to-phase voltage L3-1 min	V	√	√	x
6222/7222	7611	R	Phase-to-phase voltage L3-1 max	V	√	√	x
6224/7224	7612	R	Mean 3-phase voltage min	V	√	√	x
6226/7226	7613	R	Mean 3-phase voltage max	V	√	√	x
6228/7228	7614	R	Mean 3-phase current min	A	√	√	x
6230/7230	7615	R	Mean 3-phase current max	A	√	√	x
6232/7232	7616	R	3-phase active power min	W	√	√	x
6234/7234	7617	R	3-phase active power max	W	√	√	x
6236/7236	7618	R	3-phase reactive power min	var	√	√	x
6238/7238	7619	R	3-phase reactive power max	var	√	√	x
6240/7240	7620	R	3-phase apparent power min	VA	√	√	x

6242/7242	7621	R	3-phase apparent power max	VA	√	√	x
6242/7244	7622	R	Mean power factor (PF) min	-	√	√	x
6246/7246	7623	R	Mean power factor (PF) max	-	√	√	x
6248/7248	7624	R	Mean $Tg\phi$ factor min	-	√	√	x
6250/7250	7625	R	Mean $Tg\phi$ factor max	-	√	√	x
6252/7252	7626	R	Frequency min	Hz	√	√	√
6254/7254	7627	R	Frequency max	Hz	√	√	√
6256/7256	7628	R	Mean phase-to-phase voltage min	V	√	√	x
6258/7258	7629	R	Mean phase-to-phase voltage max	V	√	√	x
6260/7260	7630	R	Mean active power min	W	√	√	√
6262/7262	7631	R	Mean reactive power max	W	√	√	√
6264/7264	7632	R	Harmonic U1 / THD U1 min	V / %	√	x	√
6266/7266	7633	R	Harmonic U1 / THD U1 max	V / %	√	x	√
6268/7268	7634	R	Harmonic U2 / THD U2 min	V / %	√	x	x
6270/7270	7635	R	Harmonic U2 / THD U2 max	V / %	√	x	x
6272/7272	7636	R	Harmonic U3 / THD U3 min	V / %	√	x	x
6274/7274	7637	R	Harmonic U3 / THD U3 max	V / %	√	x	x
6276/7276	7638	R	Harmonic I1 / THD I1 min	A / %	√	x	√
6278/7278	7639	R	Harmonic I1 / THD I1 max	A / %	√	x	√
6280/7280	7640	R	Harmonic I2 / THD I2 min	A / %	√	x	x
6282/7282	7641	R	Harmonic I2 / THD I2 max	A / %	√	x	x
6284/7284	7642	R	Harmonic I3 / THD I3 min	A / %	√	x	x
6286/7286	7643	R	Harmonic I3 / THD I3 max	A / %	√	x	x
6288/7288	7644	R	Cosinus of angle between U1 i I1 min	-	√	x	√

6290/7290	7645	R	Cosinus of angle between U1 i I1 max		√	x	√
6292/7292	7646	R	Cosinus of angle between U2 i I2 min	-	√	x	x
6294/7294	7647	R	Cosinus of angle between U2 i I2 max	-	√	x	x
6296/7296	7648	R	Cosinus of angle between U3 i I3 min	-	√	x	x
6298/7298	7649	R	Cosinus of angle between U3 i I3 max	-	√	x	x
6300/7300	7650	R	Mean 3-phase cos min	-	√	√	x
6302/7302	7651	R	Mean 3-phase cos max	-	√	√	x
6304/7304	7652	R	Angle between U1 i I1 min	°	√	x	√
6306/7306	7653	R	Angle between U1 i I1 max	°	√	x	√
6308/7308	7654	R	Angle between U2 i I2 min	°	√	x	x
6310/7310	7655	R	Angle between U2 i I2 max	°	√	x	x
6312/7312	7656	R	Angle between U3 i I3 min	°	√	x	x
6314/7314	7657	R	Angle between U3 i I3 max	°	√	x	x
6316/7316	7658	R	Current in neutral wire min	A	√	x	x
6318/7318	7659	R	Current in neutral wire max	A	√	x	x
6320/7800	7660	R	U1 – harmonic 2	%	√	x	√
...			
6358/7838	7679	R	U1 - harmonic 21	%	√	x	√
6360/7840	7680	R	U2 - harmonic 2	%	√	x	x
...			
6398/7878	7699	R	U2 - harmonic 21	%	√	x	x
6400/7880	7700	R	U3 - harmonic 2	%	√	x	x
...			
6438/7918	7719	R	U3 - harmonic 21	%	√	x	x

6440/7920	7720	R	I1 - harmonic 2	%	√	x	√
...			
6478/7958	7739	R	I1 - harmonic 21	%	√	x	√
6480/7960	7740	R	I2 - harmonic 2	%	√	x	x
...			
6518/7998	7759	R	I2 - harmonic 21	%	√	x	x
6520/8000	7760	R	I3 - harmonic 2	%	√	x	x
...			
6558/8038	7779	R	I3 - harmonic 21	%	√	x	x
6560/8040	7780	R	Consumed ordered power	%	√	x	P1
6562/8042	7781	R	3-phase harmonic U/THD U	V/%	√	x	x
6564/8044	7782	R	3-phase harmonic I/THD I	A/%	√	x	x
6566/8046	7783	R	3-phase harmonic U/THD U min	V/%	√	x	x
6568/8048	7784	R	3-phase harmonic U/THD U max	V/%	√	x	x
6570/8050	7785	R	3-phase harmonic I/THD I min	A/%	√	x	x
6572/8052	7786	R	3-phase harmonic I/THD I max	A/%	√	x	x

In case of a lower exceeding the value -1e20 is written in, however after an upper exceeding or error occurrence, the value 1e20 is written.

9. ERROR CODES

During the meter operation, messages about errors can occur. Reasons of errors are presented below.

Err1 -when the voltage or current is too small when measuring:
- PFi, $\text{tg}\phi_i$, cos, THD, harmonic below 10% U_n ,
- PFi, $\text{tg}\phi_i$, cos, below 1% I_n ,
- THD, harmonic below 10% I_n ,
- f below 10% U_n ,
- $I_{(N)}$, below 10% I_n ;

bAd Freq - When measuring harmonics and THD, if the frequency value is beyond the interval 48 – 52 Hz for 50Hz and 58 – 62 for 60 Hz;

Err bat is displayed when the battery of the internal RTC clock is used up. The measurement is carried out after switching the supply on and every day at midnight. One can disable the message by the  push-button. The disabled message remains inactive till the renewed switching of the meter on.

Err CAL, Err EE - are displayed when the meter memory is damaged. The meter must be sent to the manufacturer.

Err PAr - are displayed when operating parameters in the meter are incorrect. One must restore manufacturer's parameters (from the menu level or through RS-485). One can disable the message by the  push-button.

Err Enrg - are displayed when energy values in the meter are incorrect. One can disable the message by the  push-button. Incorrect energy values are reset.

Err L2 L3

error of phase sequence, one must interchange the connection of phase 2 and phase 3. One can disable the message by the  push-button. Each time you power up, the message will be displayed again.

----- or ----- - lower overflow. The measured value is smaller than the lower measuring quantity range.

----- or ----- - upper overflow. The measured value is higher than the upper measuring quantity range or measurement error.

10. TECHNICAL DATA

Measuring ranges and admissible basic errors

Table 13

Measured value	Indication range*	Measuring range	L1	L2	L3	Σ	Basic error
Current In 1 A 5 A	0.00 ... 12 kA 0.00 ... 60 kA	0.002 ... 1.200 A~ 0.010 ... 6.000 A~	•	•	•		±0.2% r
Voltage L-N 57.7 V 230 V	0.0 ... 280 kV 0.0 ... 1.104 MV	2.8 ... 70.0 V~ 11.5 ... 276 V~	•	•	•		±0.2% r
Voltage L-L 100 V 400 V	0.0 ... 480 kV 0.0 ... 1.92 MV	5 ... 120 V~ 20 ... 480 V~	•	•	•		±0.5% r
Frequency	47.0 .. 63.0 Hz	47.0...63.0 Hz	•	•	•		±0.2%mv
Active power	-9999 MW .. 0.00 W .. 9999 MW	-1.65 kW...1.4 W...1.65 kW	•	•	•	•	±0.5% r
Reactive power	-9999 Mvar .. 0.00 var ... 9999 Mvar	-1.65 kvar...1.4 var...1.65 kvar	•	•	•	•	±0.5% r
Apparent power	0.00 VA .. 9999 MVA	1.4 VA...1.65 kVA	•	•	•	•	±0.5% r
Power factor PF	-1 .. 0.. 1	-1...0...1	•	•	•	•	±1% r
Tangent φ factor	-10.2...0...10.2	-1.2...0...1.2	•	•	•	•	±1% r
Cosinus φ	-1... 1	-1... 1	•	•	•	•	±1% r
φ	-180 ... 180	-180 ... 180	•	•	•		±0.5% r
Imported active energy	0 .. 99 999 999.9 kWh					•	±0.5% r
Exported active energy	0 .. 99 999 999.9 kWh					•	±0.5% r
Reactive inductive energy	0 .. 99 999 999.9 kvarh					•	±0,5%
Reactive capacitive energy	0 .. 99 999 999.9 kvarh					•	±0,5%
THD	0 .. 100%	0 .. 100%	•	•	•		±5%

* Depending on the set tr_U ratio (ratio of the voltage transformer: 0.1...4000.0) and tr_I ratio (ratio of the current transformer: 1...10000)

r - of the range

mv - of the measured value

Caution! For the correct current measurement the presence of a voltage higher than 0.05 Un is required at least in one of the phase

Power input:	
- in supply circuit	$\leq 6 \text{ VA}$
- in voltage circuit	$\leq 0.05 \text{ VA}$
- in current circuit	$\leq 0.05 \text{ VA}$
Display field:	dedicated display LCD 3.5"
Relay output:	relay, voltageless NO contacts load capacity 250 V~/ 0.5 A ~
Analog output:	current 0(4) ... 20 ... 24 mA load resistance $\leq 250 \Omega$ resolution 0.01 % of the range basic error 0.2%
Serial interface RS-485:	address 1...247; mode: 8N2,8E1, 8O1,8N1; baud rate: 4.8, 9.6, 19.2, 38.4 kbit/s transmission protocol: Modbus RTU response time: 600 ms
Energy impulse output	output of OC type (NPN), passive of class A , acc.to EN 62053-31 supply voltage 18 .. 27 V, current 10 .. 27 mA
Constant of OC type output impulse:	1000 - 20000 imp./kWh independently of set tr_U, tr_I ratios
Protection grade ensured by the casing:	
- from frontal side	IP 65
- from terminal side	IP 20
Weight	0.3 kg
Overall dimensions	96 x 96 x 77 mm

Reference and rated operating conditions

- supply voltage	85..253 V a.c. (40...400) Hz or 90..300 V d.c. 20..40 V a.c. (40...400) Hz or 20..60 V d.c.
- input signal:	0... <u>0.002...1.2</u> I_n ; <u>0.05...1.2</u> U_n for current, voltage 0... <u>0.002...1.2</u> I_n ; 0... <u>0.1...1.2</u> U_n for power factors Pf_i , $t\phi_i$ frequency <u>47...63</u> Hz sinusoidal (THD \leq 8%)
- power factor	-1...0...1
- ambient temperature	-25... <u>23</u> ...+55°C
- storage temperature	-30...+70°C
- relative humidity	25...95% (condensation inadmissible)
- admissible peak factor:	
- current intensity	2
- voltage	2
- external magnetic field	<u>0...40</u> ...400 A/m
- short duration overload (5 s)	
- voltage inputs	2 U_n (max. 1000 V)
- current inputs	10 I_n
- operating position	any
- preheating time	5 min.

Battery of the real time clock: CR2032

Additional errors:

in % of the basic error

- from frequency of input signals	< 50%
- from ambient temperature changes	< 50%/10°C
- for THD > 8%	< 100%

Standards fulfilled by the meter:

Electromagnetic compatibility:

- noise immunity acc. to EN 61000-6-2
- noise emissions acc. to EN 61000-6-4

Safety requirements:

according to EN 61010 -1 standard

- isolation between circuits: basic
- installation category: III
- pollution level: 2
- maximum phase-to-earth voltage:
 - for supply and measuring circuits 300 V
 - for remaining circuits 50 V
- altitude above sea level: < 2000 m.

11. ORDERING CODES

Table 14

Meter of network parameters ND20 -	X	X	X	X	XX	X	X
Current input In:							
1 A (X/1)	1						
5 A (X/5)	2						
Voltage input (phase/phase-to-phase) Un:							
3 x 57.7/100 V	1						
3 x 230/400 V	2						
Analog current output:							
without analog output				0			
with programmable output 0(4) ... 20 mA				1			
Supply voltage:							
85..253 V a.c., 90..300 V d.c.				1			
20..40 V a.c., 20..60 V d.c.				2			
Kind of version:							
standard					00		
custom-made*					XX		
Language:							
Spanish						S	
English						E	
French						F	
Acceptance tests:							
without extra quality requirements							0
with an extra quality inspection certificate							1
acc. to customer's requirements*							X

* - After agreeing with the manufacturer.

Example of Order:

When ordering please respect successive code numbers.

The code: **ND20- 2-2-1-1- 00- E-1** means:

ND20 – meter of network parameters of ND20 type

2 – current input I_n : 5 A (x/5),

2 – input voltage (phase/phase-to-phase) $U_n = 3 \times 230/400$ V,

1 – with programmable analog output,

1 – supply voltage: 85...253 V a.c., 90..300 V d.c.

00 – standard version

E – all descriptions and user's manual in English,

1 – with an extra quality inspection certificate.

12. MAINTENANCE AND GUARANTEE

The ND20 meter does not require any periodical maintenance. In case of some incorrect operations:

After the dispatch date and in the period stated in the guarantee card:

One should return the instrument to the Manufacturer's Quality Inspection Dept.

If the instrument has been used in compliance with the instructions, we guarantee to repair it free of charge.

The disassembling of the housing causes the cancellation of the granted guarantee.

After the guarantee period:

One should turn over the instrument to repair it in a certified service workshop.

Our policy is one of continuous improvement and we reserve the right to make changes in design and specifications of any products as engineering advances or necessity requires and to revise the above specifications without notice.



MT-ND20_EN_130717

DISEÑOS Y TECNOLOGIA S.A.

Xarol, 6B P.I. Les Guixeres
08915 Badalona - ESPAÑA
tel.: +34 933 394 758, fax +34 934 903 145
www.ditel.es

made in POLAND by:
LUMEL S.A.
www.lumel.com.pl

30722002B